



# VENUS

120V PENDANTS

location:  
**DAMP**

## SPECIFICATIONS:

### DESCRIPTION

The urban stylings of our Venus pendant are ideal for today's modern architecture, composed of intricately cut layers of tan corrugated cardboard. Each layer is precisely sized and positioned to exude a gritty spin to a visually appealing shape.

### LAMPING

**LED:** 9W Replaceable source, 120V, dimmable, 90+ CRI, 3000°K CCT, 800 lumens, 25,000 hours. Lamp included. (Additional Color Temperatures available, including 3500°K and 4000°K)

### SHADE

Shade shall be of corrugated cardboard material and includes a removable white acrylic shield. 17.75" Dia. x 7.5" H

### SUSPENSION

**Cord-hung:** 10' SVT-type cord, complete with 5" decorative sleeve at the socketholder. Jacket coordinates with metal finish. Plated stamped steel construction. Black, Bronze or Satin Nickel. See next page for mult light options.

**Stem-mount:** Includes 4 connectable stem sections (3", 6", 12" and 18" lengths) plus telescoping piece for up to 3" adjustment, 10' max. 5" Dia. canopy (with swivel) and stem sections are plated steel. Black, Bronze or Satin Nickel.

\*Additional Stem Sections can be ordered under accessories.

### MOUNTING

Installs directly to a 4" octagonal ceiling box. Suitable for sloped ceilings.

### LABELS

UL or ETL Listed. Suitable for Dry Locations (interior use only).

Consult factory concerning lower wattage labeling for energy requirements.



VENUS

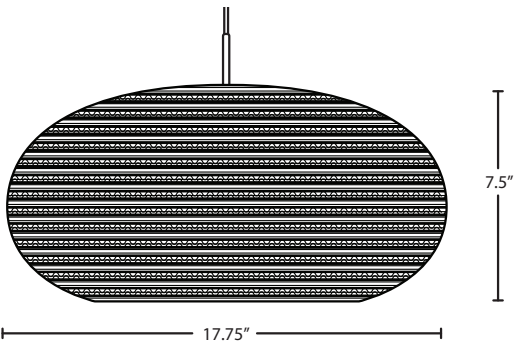

**Project Information:**

**For ordering information, see next page**

All dimensions provided are nominal.  
Allowance must be made for dimensional tolerance in handcrafted glasses.

REV 5/22



### ORDERING:

CONNECTION	SHADE OPTIONS	LAMP OPTIONS	METAL FINISH	OPTIONS
Pendant Fixtures	<b>VENUS</b> Venus	<b>LED*</b> 9W LED 120V, dimmable	<b>BK</b> Black <b>BR</b> Bronze <b>SN</b> Satin Nickel	<b>L</b> 15' cord <b>LW</b> Low wattage labeling
<b>1JC</b> Dome Canopy <b>1JT</b> Flat Canopy		<i>*CCT options available (contact factory)</i>		

Stem Fixtures  
**1TT** Flat Canopy

Multi light Cord Fixture  
**J** For Multi light Canopy



Multilight Canopies Available, see page 11

**Ex. 1JT-VENUS-LED-SN**  
Venus Pendant,  
Satin Nickel Finish, Flat Canopy

### MULTIPOINT CANOPY OPTIONS FOR CORD PENDANTS

#### T33X 3 LIGHT ROUND CANOPY

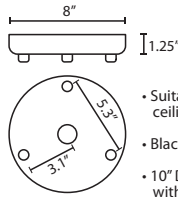

- Suitable for sloped ceilings
- Black, Bronze or Satin Nickel
- 10" Dia. shades MAX, with staggered heights
- \* For larger diameter glasses, Stemhooks are required for spacing*

#### T33XL 3 LIGHT LARGE ROUND CANOPY

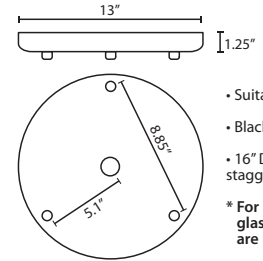

- Suitable for sloped ceilings
- Black, Bronze or Satin Nickel
- 16" Dia. shades MAX, with staggered heights
- \* For larger diameter glasses, Stemhooks are required for spacing*

#### T36X 6 LIGHT ROUND CANOPY

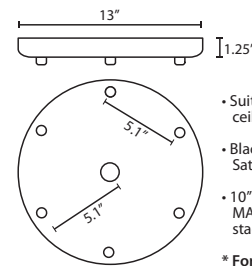

- Suitable for sloped ceilings
- Black, Bronze or Satin Nickel
- 10" Dia. shades MAX, with staggered heights
- \* For larger diameter glasses, Stemhooks are required for spacing*

#### T39X 9 LIGHT ROUND CANOPY

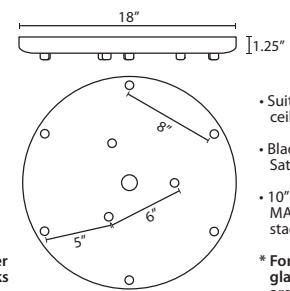

- Suitable for sloped ceilings
- Black, Bronze or Satin Nickel
- 10" Dia. shades MAX, with staggered heights
- \* For larger diameter glasses, Stemhooks are required for spacing*

### PENDANT OPTIONS:

#### 1JT / 1JC / J CORD-HUNG PENDANT

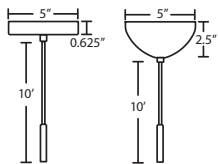

- Flat (1JT) or Dome (1JC) Canopy styles. Dome style allows adjustment without cutting cord.
- "J" option is pendant less canopy for multipoint canopy (options to the right)
- Suitable for sloped ceilings
- Cord: 10' SVT, 5" sleeve at socketholder
- Also available in 15'
- Black, Bronze or Satin Nickel
- Cord Sleeves are available in 18" lengths

#### 1TT STEM PENDANT

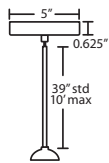

- Swivel at canopy, suitable for sloped ceilings
- Includes telescoping section plus 4 connectable stem sections, (1x 3", 1x 6", 1x 12", 1x 18"), 10' max
- Black, Bronze or Satin Nickel
- Additional Stem Sections can be ordered under Accessories

### ACCESSORIES:

#### ADDITIONAL STEM SECTIONS:

Additional connecting stems are available to increase overall length of a Stem Pendant, up to 10' max. Telescoping adjustable section allows up to 3" movement.

<b>T20A-SN, BK or BR</b>	Adj. Section
<b>T203-SN, BK or BR</b>	3" Section
<b>T206-SN, BK or BR</b>	6" Section
<b>T212-SN, BK or BR</b>	12" Section
<b>T218-SN, BK or BR</b>	18" Section

#### LONGER CORD LENGTHS:

Longer cord length of 15' available. Add an "L" to the end of the item number, i.e. 1JC-169707-SN-L.

#### LOW WATTAGE LABELING:

Incandescent fixture supplied with 16 watt relamp label. Add an "LW" to the end of the item number, i.e. 1JC-169707-SN-LW.

#### CORD SLEEVES:

If concealing the cord is desired on a Cord-hung Pendant, order our 0.25" dia. metal sleeves. Each sleeve is 18" long and may be field cut.

<b>T118-BK</b>	Black
<b>T118-BR</b>	Bronze
<b>T118-SN</b>	Satin Nickel

#### STEMHOOKS:

Suspension hooks allow cord drops to be placed wherever desired. Suitable for sloped ceilings or for greater multilight spacing

<b>T103BK</b>	Black
<b>T103BR</b>	Bronze
<b>T103SN</b>	Satin Nickel

#### T33V 3 LIGHT BAR CANOPY

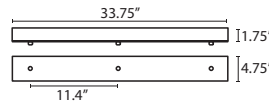

- Suitable for sloped ceilings
- Black, Bronze or Satin Nickel
- 20" Dia. shades MAX, with staggered heights
- \* For larger diameter glasses, Stemhooks are required for spacing*

#### T34V 4 LIGHT BAR CANOPY

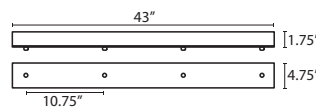

- Suitable for sloped ceilings
- Black, Bronze or Satin Nickel
- 20" Dia. shades MAX, with staggered heights
- \* For larger diameter glasses, Stemhooks are required for spacing*

#### T37V 7 LIGHT BAR CANOPY

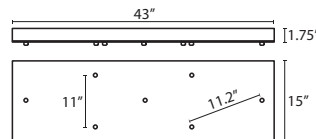

- Suitable for sloped ceilings
- Black, Bronze or Satin Nickel
- 20" Dia. shades MAX, with staggered heights
- \* For larger diameter glasses, Stemhooks are required for spacing*

### HOW TO ORDER A MULTILIGHT FIXTURE

Order your canopy with the selected 120V multi light pendants (indicated by "B" or "J" prefix) for the complete fixture:

**Example: 1x T33X-SN (3 Light Round Canopy)**

- 1x J-VENUS-SN (Venus Pendant)**
- 1x J-VENUS-SN (Venus Pendant)**
- 1x J-VENUS-SN (Venus Pendant)**