



# SUZI 11 / 14 / 18

120V PENDANTS

## SPECIFICATIONS:

### DESCRIPTION

The Suzi is a slender yet shapely handcrafted European glass with a open top and bottom. Available in 3 different sizes.

### LAMPING

**Standard:** 100W A19 120V incandescent, lamp not included. Dimmable with standard incandescent dimmer (not included).

**LED:** 9W Replaceable source, 120V, dimmable, 90+ CRI, 3000°K CCT, 800 lumens, 30,000 hours. Lamp included. (Standard CCT is 3000K, 3500K and 4000K are also available)

### DIFFUSER

Shade shall be handcrafted glass of various decors.

**Suzi 11:** 3.5" Dia. x 11.25" H

**Suzi 14:** 4.25" Dia. x 14.5" H

**Suzi 18:** 6" Dia. x 18" H

### SUSPENSION

**Cord-hung:** 10' SVT-type cord, complete with 5" decorative sleeve at the socketholder. Jacket coordinates with metal finish. Plated stamped steel construction. Black, Bronze or Satin Nickel. See next page for mult light options.

**Cable-hung:** 1x 10' aircraft-quality stainless steel cable support with 10' AWM-type cord. Jacket coordinates with metal finish. 5" Dia. dome canopy is plated stamped steel. Black, Bronze or Satin Nickel.

**Stem-mount:** Includes 4 connectable stem sections (3", 6", 12" and 18" lengths) plus telescoping piece for up to 3" adjustment, 10' max. 5" Dia. canopy (with swivel) and stem sections are plated steel. Black, Bronze or Satin Nickel.

\*Additional Stem Sections can be ordered under accessories.

### MOUNTING

Installs directly to a 4" octagonal or round ceiling box. Suitable for sloped ceilings.

### LABELS

UL or ETL Listed. Suitable for Damp Locations (interior use only).

Consult factory concerning lower wattage labeling for energy requirements.



SUZI 11 IN CARRERA (412119)  
SUZI 14 IN OPAL MATTE (489707) & SUZI 18 IN CARRERA (412719)

Suzi 11: #4121

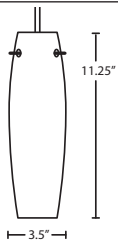

Suzi 14: #4897

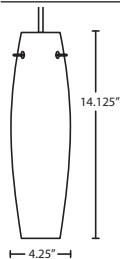

Suzi 18: #4127

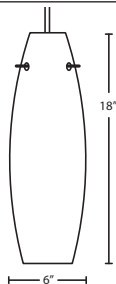

**Project Information:**

**For ordering information, see next page**

All dimensions provided are nominal.  
Allowance must be made for dimensional tolerance in handcrafted glasses.

**REV 8/24**



ORDERING:

CONNECTION	SHADE OPTIONS	LAMP OPTIONS	METAL FINISH	OPTIONS
Cord Fixture	<b>412107</b> 11" Opal Matte	(blank) E26 base	<b>BK</b> Black	<b>L</b> 15' cord
<b>1JC</b> 1 Lt. Dome	<b>412119</b> 11" Carrera	<b>LED*</b> 9W LED	<b>BR</b> Bronze	<b>LW</b> Low wattage labeling
<b>1JT</b> 1 Lt. Flat	<b>489707</b> 14" Opal Matte	*CCT options available (contact factory)	<b>SN</b> Satin Nickel	
	<b>489719</b> 14" Carrera			
Cable Fixture	<b>412707</b> 18" Opal Matte			
<b>1KX</b> 1 Lt. Dome	<b>412719</b> 18" Carrera			

Stem Fixture  
**1TT** 1 Lt. Flat

Multi light  
**J** For Multi light Canopy



Multilight Canopies Available, see pg. see right

**Ex. 1JT-489707-SN**  
Suzi Pendant w/ Opal Matte Glass Shade, Satin Nickel Finish, Flat Canopy

MULTIPOINT CANOPY OPTIONS FOR CORD PENDANTS

T33X 3 LIGHT ROUND CANOPY

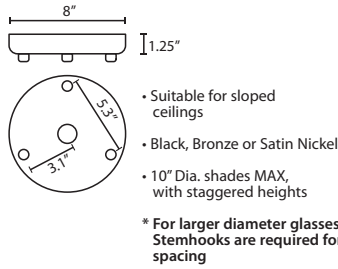

T33XL 3 LIGHT LARGE ROUND CANOPY

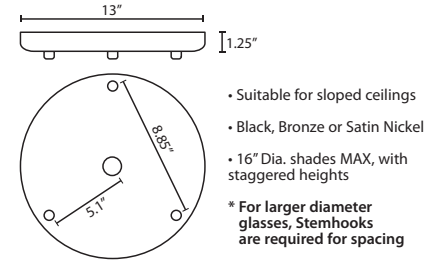

T36X 6 LIGHT ROUND CANOPY

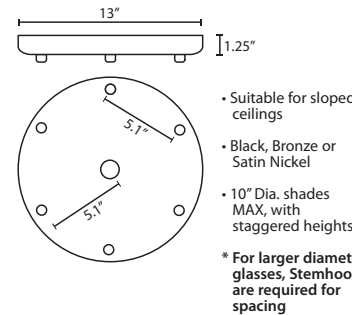

T39X 9 LIGHT ROUND CANOPY

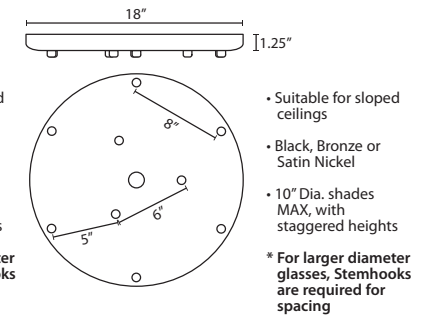

T38X 8 LIGHT SQUARE CANOPY

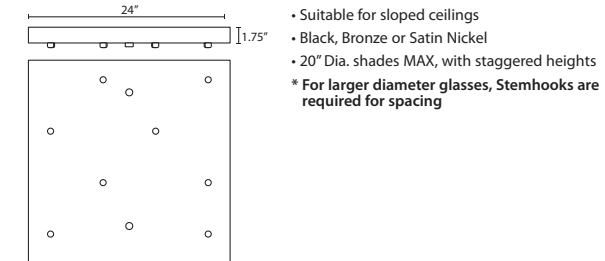

T33V 3 LIGHT BAR CANOPY

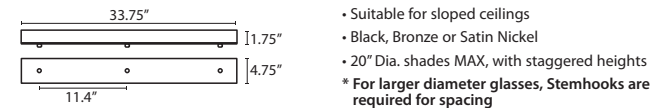

T34V 4 LIGHT BAR CANOPY

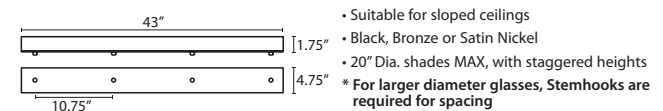

T37V 7 LIGHT BAR CANOPY

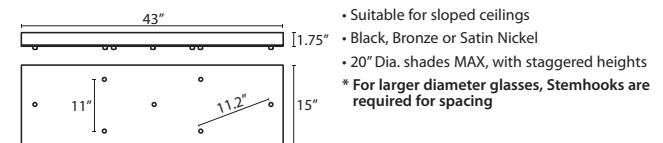

PENDANT OPTIONS:

1JT / 1JC / J CORD-HUNG PENDANT

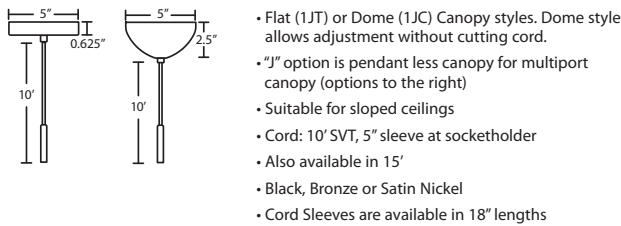

1TT STEM PENDANT

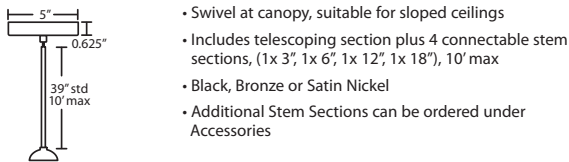

1KX CABLE-HUNG PENDANT

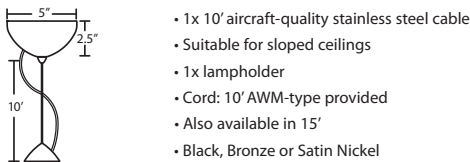

ACCESSORIES:

ADDITIONAL STEM SECTIONS:

Additional connecting stems are available to increase overall length of a Stem Pendant, up to 10' max. Telescoping adjustable section allows up to 3" movement.

<b>T20A-SN, BK or BR</b>	Adj. Section
<b>T203-SN, BK or BR</b>	3" Section
<b>T206-SN, BK or BR</b>	6" Section
<b>T212-SN, BK or BR</b>	12" Section
<b>T218-SN, BK or BR</b>	18" Section

LONGER CORD LENGTHS:

Longer cord length of 15' available. Add an "L" to the end of the item number, i.e. 1JC-169707-SN-L.

LOW WATTAGE LABELING:

Incandescent fixture supplied with 16 watt relamp label. Add an "LW" to the end of the item number, i.e. 1JC-169707-SN-LW.

CORD SLEEVES:

If concealing the cord is desired on a Cord-hung Pendant, order our 0.25" dia. metal sleeves. Each sleeve is 18" long and may be field cut.

<b>T118-BK</b>	Black
<b>T118-BR</b>	Bronze
<b>T118-SN</b>	Satin Nickel

STEMHOOKS:

Suspension hooks allow cord drops to be placed wherever desired. Suitable for sloped ceilings or for greater multilight spacing

<b>T103BK</b>	Black
<b>T103BR</b>	Bronze
<b>T103SN</b>	Satin Nickel

HOW TO ORDER A MULTILIGHT FIXTURE

Order your canopy with the selected 120V multi light pendants (indicated by "B" or "J" prefix) for the complete fixture:

Example: 1x T33X-SN (3 Light Round Canopy)

1x J-489719-SN (Suzi 14 Pendant in Carrera)

1x J-489719-SN (Suzi 14 Pendant in Carrera)

1x J-489719-SN (Suzi 14 Pendant in Carrera)